

VALA M2R 2.3" Recessed Linear Light

Drywall - Surface

IMPORTANT

1. Read all instructions.
2. Install in accordance with national and local electrical code regulations.
3. This product is intended to be installed and serviced by a qualified, licensed electrician.
4. Do not install in wet locations. For dry and damp use only.
5. Turn off electrical power before installing or servicing fixture in any way.
6. To reduce the risk of fire and overheating, make sure all connections are tight.
7. Under no circumstances can the lighting fixture be covered with heat insulation gasket or similar materials.
8. The maximum connection of each input line is 40FT(1200CM) in 120AC, 80FT (2400CM) in 230AC, 100FT(3000CM) in 277AC.

PRE-INSTALLATION

Assemble Luminaire

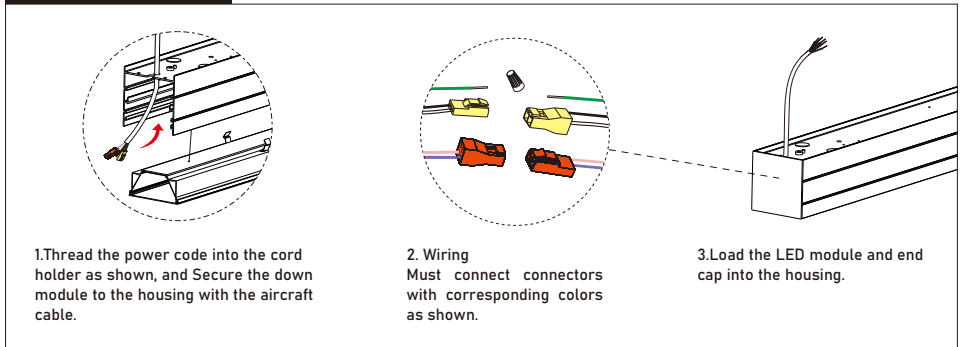

ACCESSORY

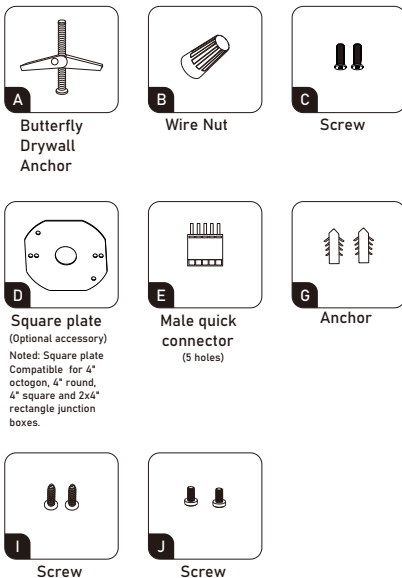

INDEPENDENT INSTALLATION

1 Prepare mounting point in the ceiling

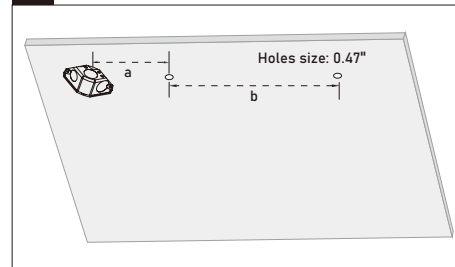

a: The center distance between the ceiling hole and the junction box.

b: The distance between two ceiling hole.

2 Mount plate and wiring

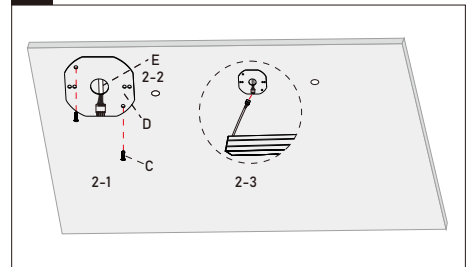

2-1: Cover the junction box with square plate "D" and fix it with screw "C", then plastering.

2-2: Plug in AC wires, dimming wires and ground wire into the male quick connector (5holes) "E" according to label instructions.

2-3: Plug in the male and female connector together, hide all wires into the junction box.

WIRING

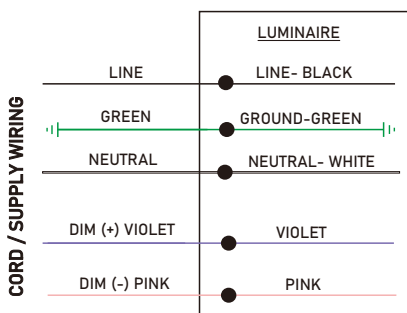

! Please isolate two dimming wires by P2 terminal individually if no need dimming; **MUST connect wires with corresponding colors as shown.**

Nominal Length	2.3" or 3.8" Width Linear-Version1 (Diffuser, Regress, WallWash)		2.3" Width Linear-Version2			
			2.3" Width Linear (Diffuser, Regress, WallWash)		2.3" Width Linear (Reflector, Louver)	
	"a" Feet	"b" Feet	"a" Feet	"b" Feet	"a" Feet	"b" Feet
2 ft.	0.48'	0.88'	0.26'	1.30'	0.26'	1.31'
3 ft.	0.48'	1.88'	0.26'	2.30'	0.26'	2.30'
4 ft.	0.48'	2.88'	0.26'	3.30'	0.26'	3.28'
8 ft.	0.48'	6.84'	0.26'	7.26'	0.26'	7.22'

3 Screw the housing in the ceiling

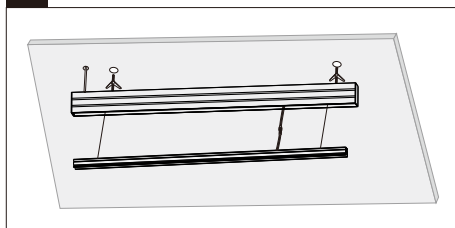

3-1: Fix the housing in the ceiling with butterfly drywall anchor "A".

Remark : Fix the housing with screws "I" if wooden frame ceiling. Fix the housing with anchor "G" and Screws "I" if cement drywall.

3-2: Press the LED modular into housing.

4 Complete



VALA M2R 2.3" Recessed Linear Light

Multiple Luminaires Connection

JOINER OPTIONS

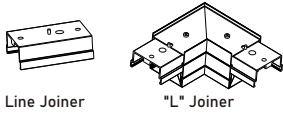

Noted: It needs 2 inputs if using joiner "T", "+" and "Y".

ACCESSORY



Noted: Silicone Seal is used to seal seams that may appear at both ends of luminaires when multiple connections.

BEFORE CONNECTING

Disassemble Luminaires

LINE CONNECTION

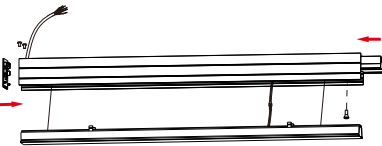

Start of run (SoR):

Install the power feed cable, head end cap and endmost line joiner. Meanwhile secure the down module to the housing with aircraft cable.



Middle of run (MoR):

Install the endmost line joiner, and secure the down module to the housing with aircraft cable.

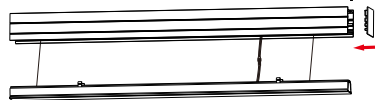

End of run (EoR):

Install the endmost end cap, and secure the down module to the housing with aircraft cable.

L SHAPE CONNECTION

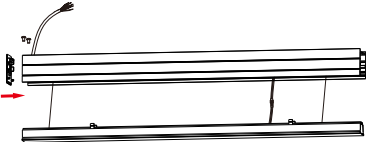

Start of run (SoR):

Install the power feed cable and head end cap. Meanwhile secure the down module to the housing with aircraft cable.

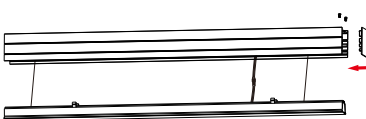

End of run (EoR):

Install the endmost end cap, and secure the down module to the housing with aircraft cable.

LINE CONNECTION

1 Prepare mounting point in the ceiling

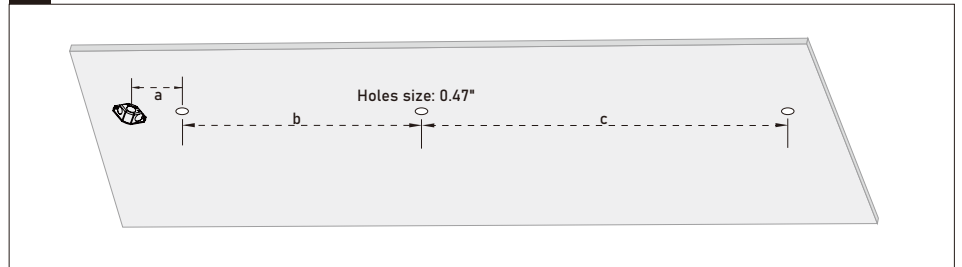

Nominal Length	2.3" or 3.8" Width Linear - Version 1 (Diffuser, Regress, Wall Wash)			2.3" Width Linear (Diffuser, Regress, Wall Wash)			2.3" Width Linear (Reflector, Louver)		
	"a" Feet	"b" Feet	"c" Feet	"a" Feet	"b" Feet	"c" Feet	"a" Feet	"b" Feet	"c" Feet
2ft.	0.48'	0.88'	1.96'	0.26'	1.30'	1.96'	0.26'	1.31'	1.97'
3ft.	0.48'	1.88'	2.96'	0.26'	2.30'	2.96'	0.26'	2.30'	2.95'
4ft.	0.48'	2.88'	3.96'	0.26'	3.30'	3.96'	0.26'	3.28'	3.94'
8ft.	0.48'	6.84'	7.92'	0.26'	7.26'	7.92'	0.26'	7.22'	7.87'

2 Mount plate and wiring

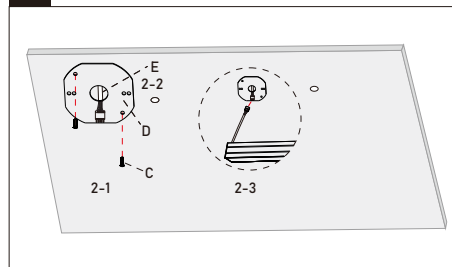

2-1: Cover the junction box with square plate "D" and fix it with screw "C", then plastering.

2-2: Plug in AC wires, dimming wires and ground wire into the male quick connector (5holes) "E" according to label instructions.

2-3: Plug in the male and female connector together, hide all wires into the junction box.

3 Install the housing and joiner - SoR

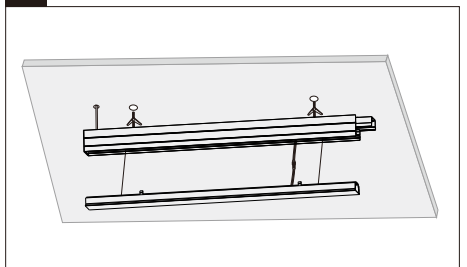

3-1: Fix the housing in the ceiling with butterfly drywall anchor "A".

Remark: Fix the housing with screws "I" if wooden frame ceiling. Fix the housing with Anchor "G" and Screws "I" if cement drywall.

4 Repeat install and join steps-MoR to EoR

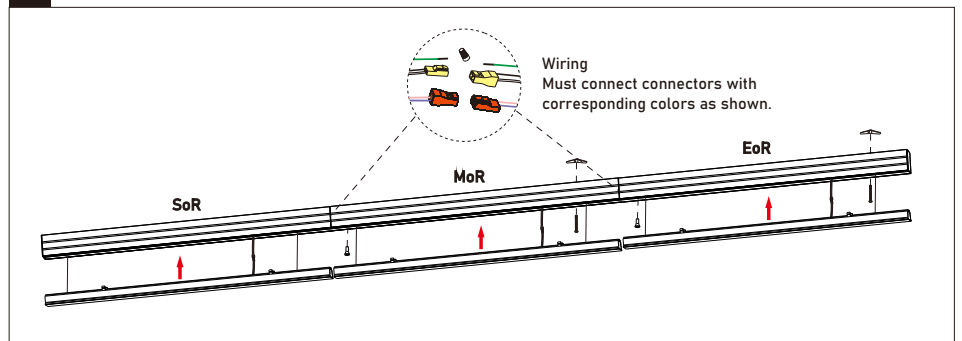

4-1: Fix the housing in the ceiling in turn.

4-2: Connect the quick connectors properly.

4-3: Insert all the led modules into the housing from SoR to EoR in turn.

VALA M2R 2.3" Recessed Linear Light

Multiple Luminaries Connection

5 Complete

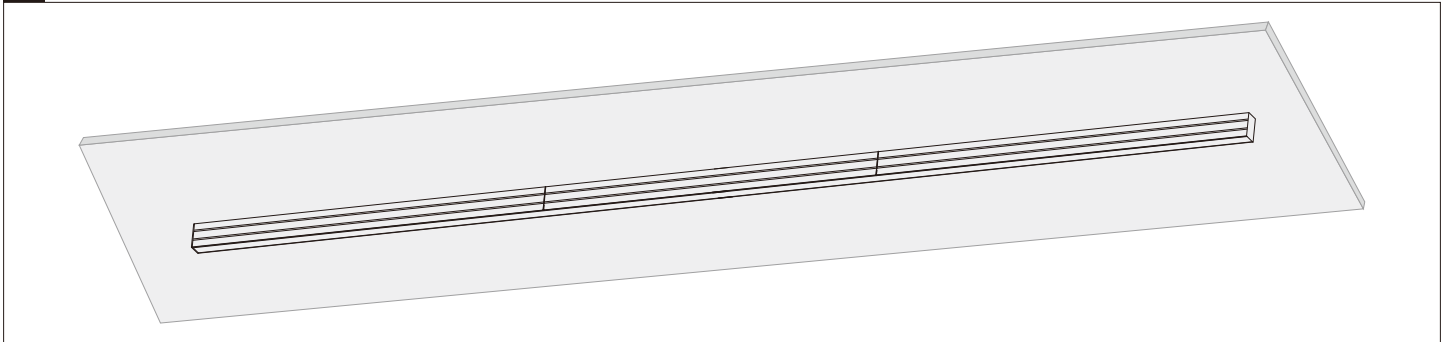

Optional 42' Diffuser Lens Roll

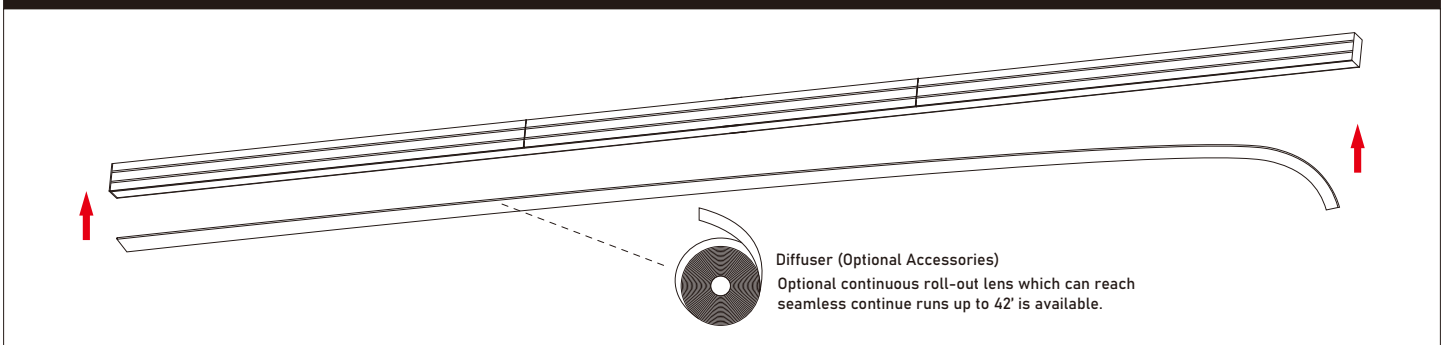

L SHAPE CONNECTION

- ▲ For "T", "Y" shape or other geometric shapes, all subject to the "L" shape installation
- ▲ It needs 2 inputs if using joiner "T", and "Y".

1 Make hole in the ceiling

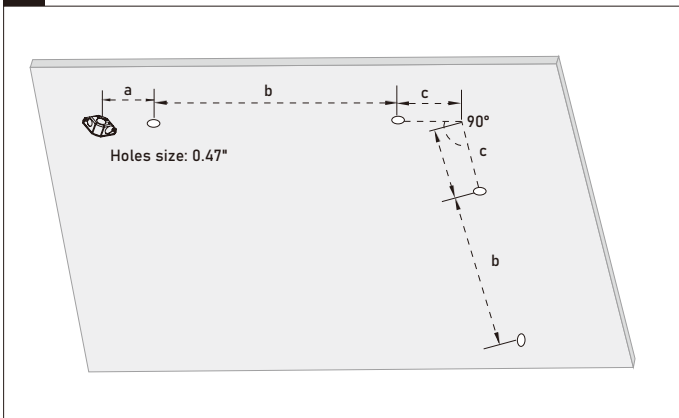

2 Mount plate and wiring

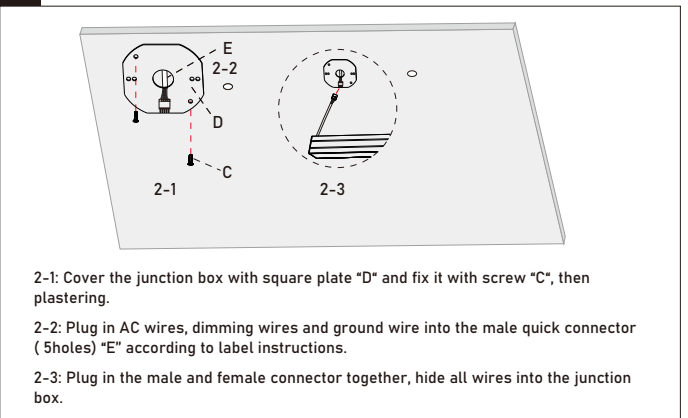

Nominal Length	3.8" Width Linear - Version 1 (Diffuser, Regress, Wall Wash)			2.3" Width Linear - Version 1 (Diffuser, Regress, Wall Wash)			2.3" Width Linear (Diffuser, Regress, Wall Wash)				2.3" Width Linear (Reflector, Louver)		
	"a"	"b"	"c" Illuminated "L" Joinder	"a"	"b"	"c" Illuminated "L" Joinder	"a"	"b"	"c" Illuminated "L" Joinder	Non-luminous "L" Joinder	"a"	"b"	Non-luminous "L" Joinder
2 ft.	0.48'	0.88'	0.39'	0.48'	0.88'	0.33'	0.26'	1.30'	0.33'	0.10'	0.26'	1.31'	0.10'
3 ft.	0.48'	1.88'	0.39'	0.48'	1.88'	0.33'	0.26'	2.30'	0.33'	0.10'	0.26'	2.30'	0.10'
4 ft.	0.48'	2.88'	0.39'	0.48'	2.88'	0.33'	0.26'	3.30'	0.33'	0.10'	0.26'	3.28'	0.10'
8 ft.	0.48'	6.84'	0.39'	0.48'	6.84'	0.33'	0.26'	7.26'	0.33'	0.10'	0.26'	7.22'	0.10'

VALA M2R 2.3" Recessed Linear Light

Multiple Luminaries Connection

