

25FT STRAIGHT ROUND STEEL POLE

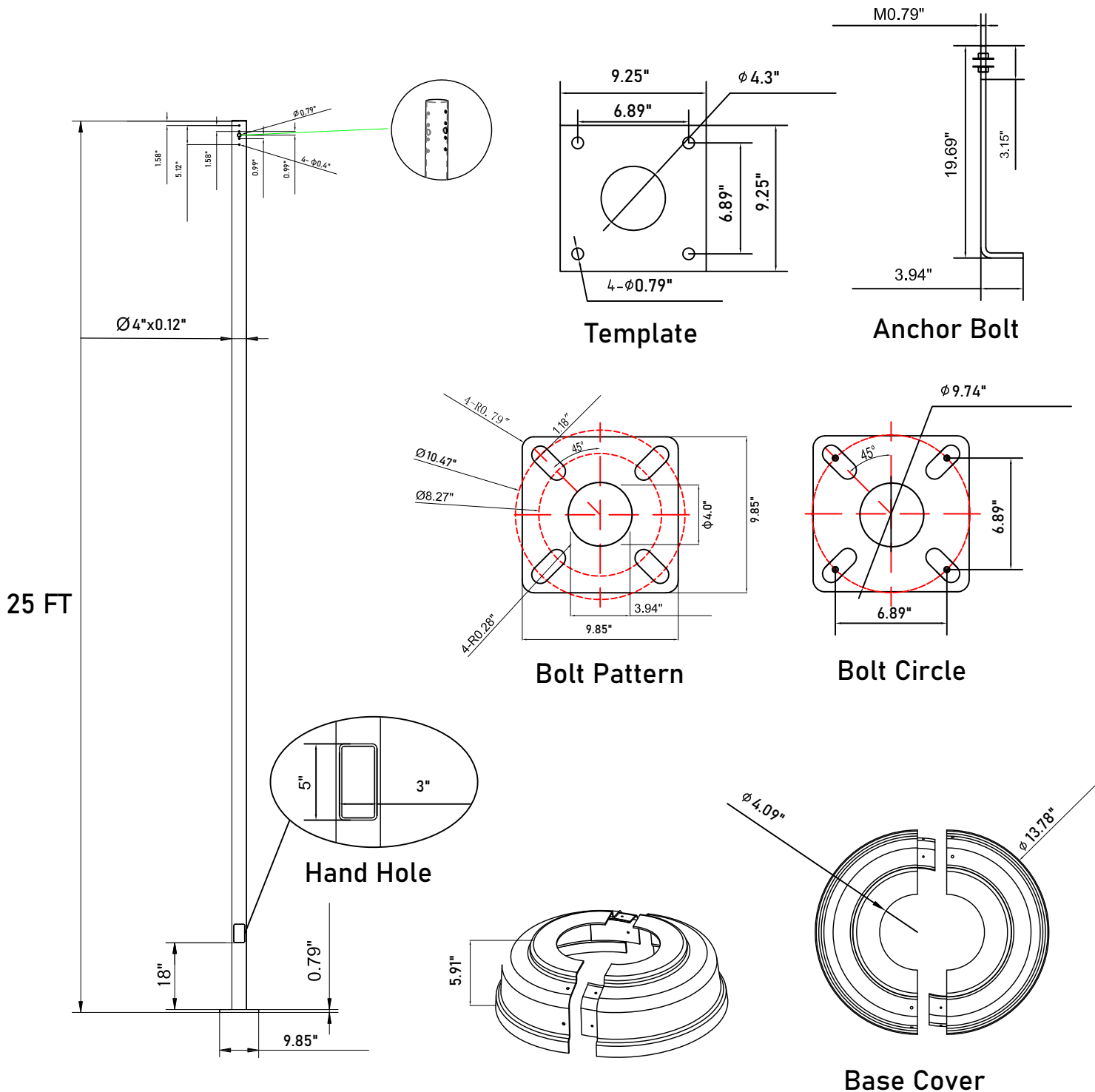

WEIGHT	
Pole = 176 lbs	Anchor Bolt = 10.5 lbs
Base Cover = 5.1 lbs	Template = 0.7 lbs

- The pole shall be made of Q235 Steel. The surface and inside of the pole shall be dipped in zinc and then sprayed on the surface. Failed to chamfer 0.5 mm.
- All welding shall be full, and there shall be no false welding, burr or other defects.
- The unmarked tolerance shall be executed according to the common tolerance table.