

WPLS1 LED Wall Pack Light



WARNING

PLEASE READ ALL INSTRUCTIONS BEFORE ATTEMPTING INSTALLATION

- To prevent personal injury or product damage only licensed electricians should install.
- To avoid electric shock or component damage disconnect power before attempting installation or servicing.
- This product must be installed in accordance with the national electric code (NEC) and all applicable federal, state and local electric codes and safety standards.
- Disconnect product and allow cooling prior to servicing.
- Any alteration or modification of this product is expressly forbidden as it may cause serious personal injury, death, property damage and/or product malfunction.
- To prevent product malfunction and/or electrical shock this product must be properly grounded.
- This luminaire is designed to operate in ambient temperatures ranging from -30°C to 40°C and to be horizontally mounted with the LEDs facing down.
- Wall mount only.
- THIS PRODUCT MUST BE INSTALLED IN ACCORDANCE WITH THE APPLICABLE INSTALLATION CODE BY A PERSON FAMILIAR WITH THE CONSTRUCTION AND OPERATION OF THE PRODUCT AND THE HAZARDS INVOLVED
- IN 75°C SUPPLY CONDUCTORS
- This product is not available for several special environments, such as places with corrosive gas liquids or high pressure water vapor.

MOUNTING TO A WALL

1. Open the Back Box by loosening the Locking Screw.
2. Verify and remove only necessary Gasket material where Back Box will mount.
3. Knock-out Back Box material for necessary mounting location.
4. Mount Back Box to Junction Box securely, using hardware supplied by others.
5. Connect electrical connections with fixture wiring.

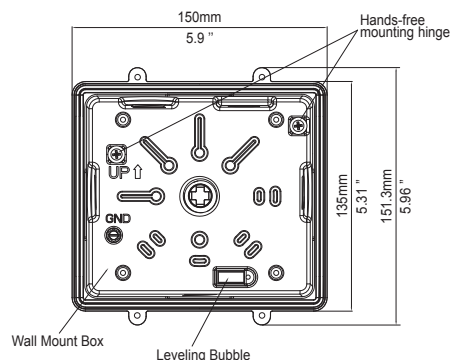

6. Seal Back Box to Housing by pushing on front of Housing while tightening Locking Screw to ensure that screw is fully seated in the Housing Recess.

Ensure wiring remains within Back Box and wires do not get pinched.

Using a silicone rubber will ensure a watertight seal.

7. If light output angle needs to be adjusted, loosen screw to rotate the fixture to desired light output angle. Tighten screw once desired light output angle is achieved.

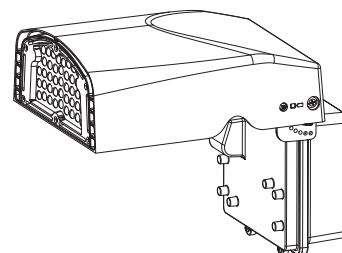
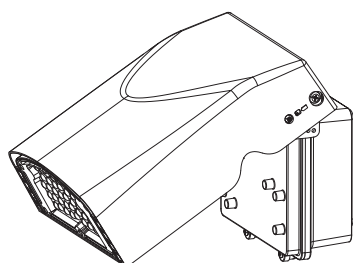
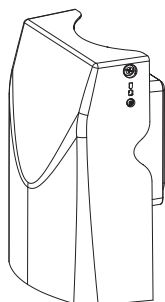
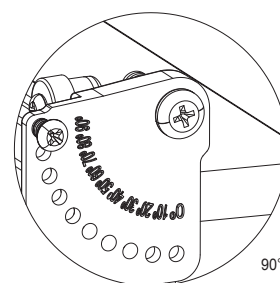
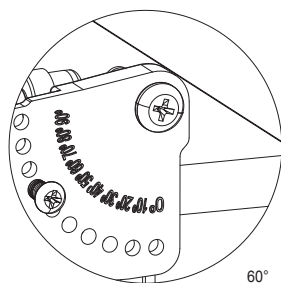
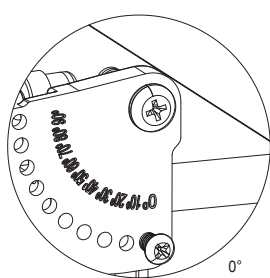
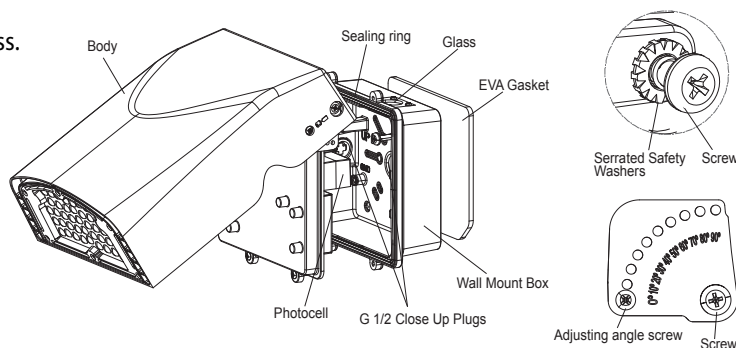

WPLS1 LED Wall Pack Light

ON-OFF WIRING

Universal voltage driver permits operation at 60 Hz except fixtures factory ordered with a 120-277VAC (P0) or 347VAC photocell (P3)

1. Connect the BLACK fixture lead to the (+) LINE supply lead.
2. Connect the WHITE fixture lead to the (-) COMMON supply lead.
3. Connect the Yellow Green wire from fixture to supply ground.

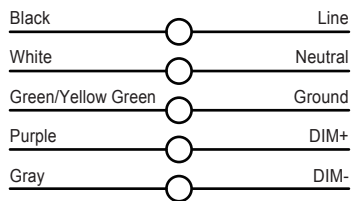

Fig. 1

CLEANING & MAINTENANCE

CAUTION: Be sure fixture temperature is cool enough to touch. Do not clean or maintain while fixture is energized.

1. Clean glass lens with non-abrasive glass cleaning solution.
2. Do not open the fixture to clean the LED. Do not touch the LED.

PHOTOCELL INSTALLATION

1. Install photocell and wire as per diagram.
2. Use photocell rated for your supply voltage.

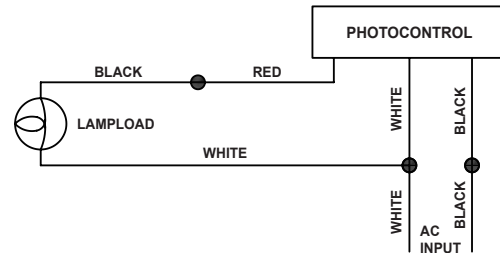

TROUBLESHOOTING

1. Check that the line voltage at the fixture is correct. Refer to wiring directions.
2. Is the fixture grounded properly?
3. Be sure the photocell, if used, is functioning properly.