

Project Name:  
 Part Number:  
 Fixture Type  
 Notes:

## VALA M2 2.3" Tunable Up / Down Architectural Linear Light

### FEATURES

#### CCT & CRI

CCT Selectable 3000K / 3500K / 4000K, CRI > 80

#### AMBINET TEMPERATURE

Suitable for use in 32°F to 104°F (0°C to 40°C)

#### EFFICACY

110 LM/W, 1,030 Lumens/ft, 9.65 Watts/ft

#### HOUSING

Extruded aluminum housing with powder coat finish

#### MOUNTING

Pendant: Aircraft cable provided with cable grippers for easy adjustment after installation  
 Surface: For direct ceiling and wall mounting



#### DRIVERS

Standard 120 - 277V, 1 - 10V Dimming down to 10%. Power factor >0.9, THD <20%  
 120V connections up to 40ft. 277V connections up to 100ft



### ORDERING INFORMATION

#### EXAMPLE: VALA M2 4FT SCT TD WT UNV LPS

Series	Width	Length	CCT	Light Distribution	Finish	Voltage	Lumen Package
VALA	M2 2.3"	2FT 2 feet 4FT 4 feet 8FT 8 feet  *Connected	SCT Selectable 3000K 3500K 4000K	TD Tunable Up/Down Distributions 100% up light 90% down / 10% up 70% down / 30% up 50% down / 50% up 30% down / 70% up 10% down / 90% up 100% down light	WT White BK *Black	UNV 120 - 277V	LPS selectable High - 1000 lm/ft Medium - 750 lm/ft Low - 500 lm/ft

\*Connected: 120V continuous run up to 40FT. 277V continuous run up to 100FT. In increments of 4'. The fixture lengths come in 4' and 8'

\*Black: black finish - consult factory for availability

### MOUNTING OPTIONS & ACCESSORIES

Mounting Accessories	Joiner	Suspended Kits	EB Driver
<b>DWCA Dry Ceiling Kit (Round / Square)</b> (1 pcs 2" canopy + 1 pcs 4" canopy White/black finish optional)	<b>VA2.3CS -</b> Line Joiner " - "	<b>SPFC01</b> 5' Suspended Power Feed & Cable (1 pcs 5ft power cord + 2 pcs 5ft aircraft cables)	<b>EM-H08170</b> 8w Emergency backup battery
<b>FDCA Flat Drop Ceiling Kit</b> (2 set flat T-grid clips + 1 pcs J-Box + 1 pcs 4" canopy + 1 pcs 2" canopy. Compatible with 9/16" or 15/16" flat grid)	<b>VA2.3CS - T</b> Line Joiner " T "	<b>SPFC02</b> 12' Suspended Power Feed & Cable (1 pcs 12ft power cord + 2 pcs 12ft aircraft cables)	<b>EM-H25170</b> 25w Emergency backup battery
<b>SDCA 9/16" Slot Drop Ceiling Kit</b> (2 set 9/16" slot T-grid clips + 1 pcs J-BOX + 1 pcs 4" canopy + 1 pcs 2" canopy)	<b>VA2.3CS - +</b> Line Joiner " + "		
<b>SMA Surface and Wall Mount Kit</b> (Square Plate + Male Quick Connector + Butterfly Drywall Anchor)	<b>VA2.3CS - Y</b> Line Joiner " Y "		
	<b>VA2.3CS - L</b> Line Joiner " L "		
	<b>VA2.3CS - V</b> Line Joiner " V "		
	<b>VA2.3CS - Z</b> Line Joiner " Z "		

## DIMENSIONS

### VALA M2 - 2 Foot

2' Length - Weight: 3.95 lbs.

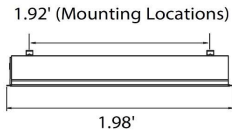

### VALA M2

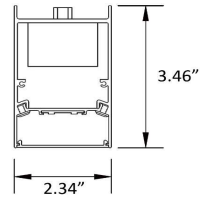

### VALA M2 - 4 Foot

4' Length - Weight: 6.5 lbs.

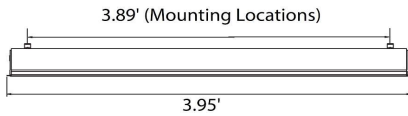

### VALA M2 - 8 Foot

8' Length - Weight: 12.5 lbs.

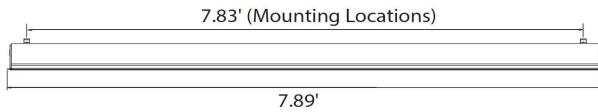

## LINE CONNECTION

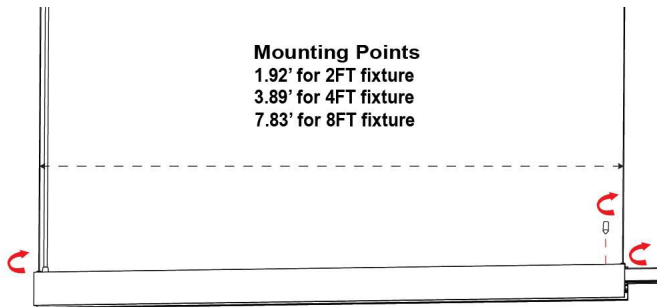
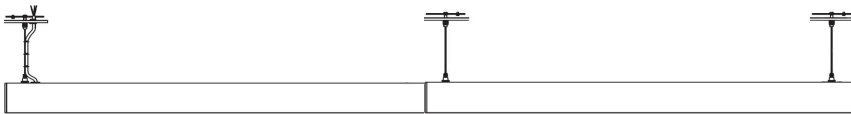

The middle hole of the  
joiner is aligned with the  
shell edge

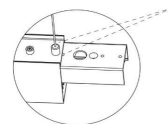

# ORE LIGHTING

## SELECTABLE LIGHTING DISTRIBUTIONS

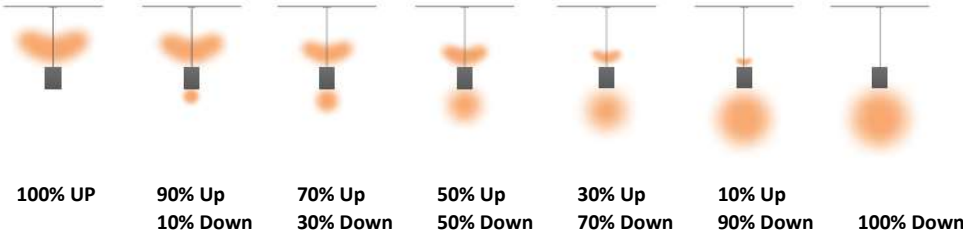

## PATTERN CONNECTORS

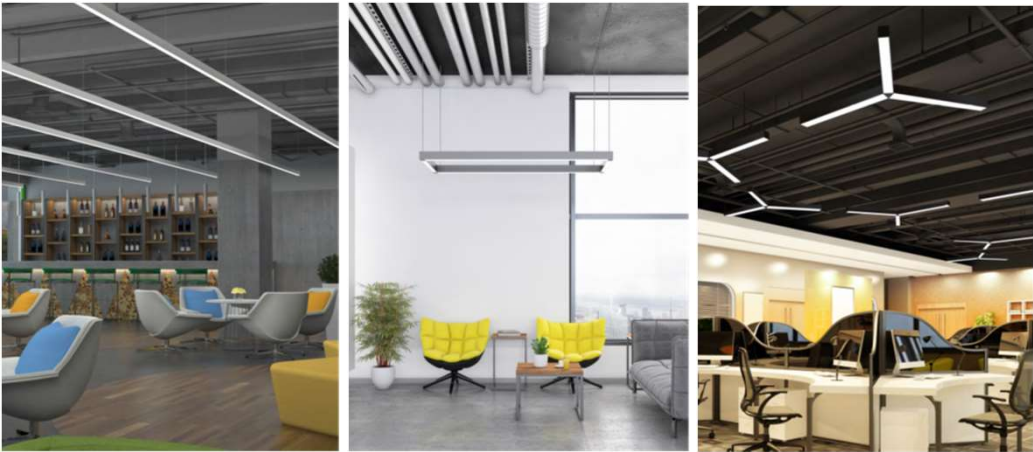
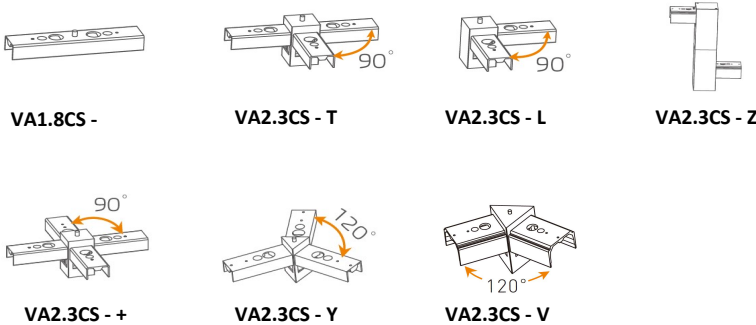

# ORE LIGHTING

## CEILING MOUNT

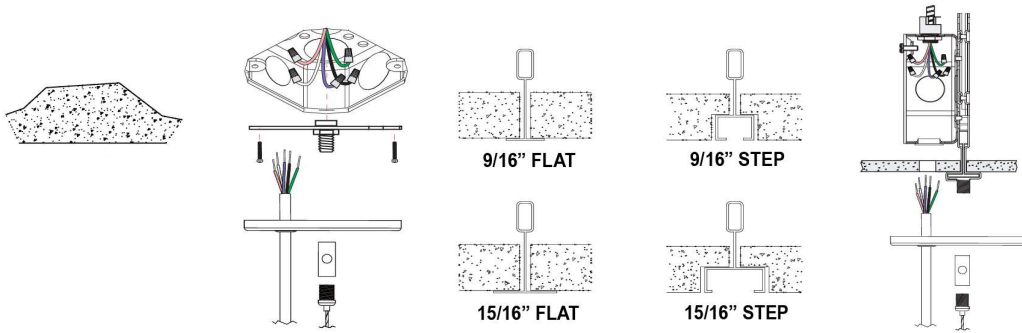

**DAY CEILING / OFF GRID**

**DROP CEILING / ON GRID**

## MOUNTING CANOPY SIZE

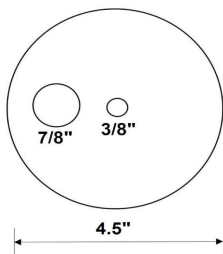

**POWER FEED CANOPY**  
(DWCA Round)

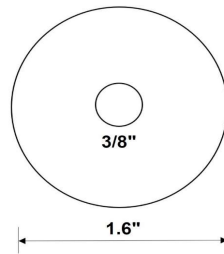

**HANG CANOPY**  
(DWCA Round)

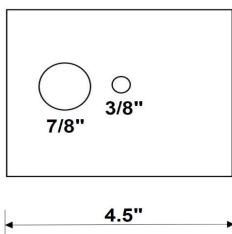

**POWER FEED CANOPY**  
(DWCA Square)

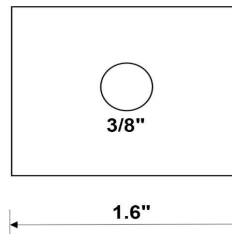

**HANG CANOPY**  
(DWCA Square)

# ORE LIGHTING

## 120V / 277V - CONTINUOUS RUN

120V Max run with single power feed up to 40ft  
 270V Max run with single power feed up to 100ft

Run Length (ft)	4ft	8ft	Line Joiner -	5' Power Cable	5' Aircraft Cable	Canopy
4	1	-	-	1	2	2
8	-	1	-	1	2	2
12	1	1	1	1	3	3
16	-	2	1	1	3	3
20	1	2	2	1	4	4
24	-	3	2	1	4	4
28	1	3	3	1	5	5
32	-	4	3	1	5	5
36	1	4	4	1	6	6
40	-	5	4	1	6	6
44	1	5	5	1	7	7
48	-	6	5	1	7	7
52	1	6	6	1	8	8
56	-	7	6	1	8	8
60	1	7	7	1	9	9
64	-	8	7	1	9	9
68	1	8	8	1	10	10
72	-	9	8	1	10	10
76	1	9	9	1	11	11
80	-	10	9	1	11	11
84	1	10	10	1	12	12
88	-	11	10	1	12	12
92	1	11	11	1	13	13
96	-	12	11	1	13	13
100	1	12	12	1	14	14

## PHOTOMETRIC

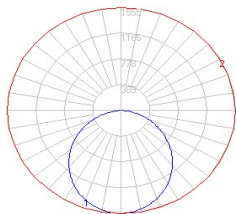

VALA M1 2FT&4FT

2FT			4FT		
ZONE	Lumens	%Lum	ZONE	Lumens	%Lum
FL(0-30)	289.5	13.9	FL(0-30)	594.0	13.9
FM(30-60)	532.1	25.6	FM(30-60)	1090.4	25.6
FH(60-80)	193.9	9.3	FH(60-80)	396.1	9.3
FVH(80-90)	15.9	0.8	FVH(80-90)	31.2	0.7
BL(0-30)	290.5	14.0	BL(0-30)	597.4	14.0
BM(30-60)	536.1	25.8	BM(30-60)	1103.9	25.9
BH(60-80)	196.9	9.5	BH(60-80)	404.9	9.5
BVH(80-90)	16.7	0.8	BVH(80-90)	33.0	0.8
UL(90-100)	0.5	0.0	UL(90-100)	0.7	0.0
UH(100-180)	5.7	0.3	UH(100-180)	11.4	0.3